

A Guide to Safety with Chainsaws

UPDATED: NOVEMBER 2011



DOL 11965 NOV11

Published by the Department of Labour
Wellington
New Zealand
First edition, September 2007
ISBN 978-0-478-33328-2

2nd edition revised April 2010

TABLE OF CONTENTS

Table of Contents	3
About this Guideline	4
Basic Rights and Responsibilities under the Health and Safety in Employment Act 1992	5
Work Area Safety	6
Know Your Capabilities.....	8
Chainsaw Selection.....	10
Know Your Chainsaw	11
Personal Safety Equipment.....	16
Checking Your Chainsaw	19
Starting the Chainsaw.....	21
Cutting with the chainsaw	23
Avoiding Kickback	26
Refuelling the Chainsaw	28
Care of Your Chain	29
Avoiding Health Problems.....	36
General chainsaw Maintenance	37

ABOUT THIS GUIDELINE

The chainsaw is an indispensable labour saving aid used by thousands of New Zealand farmers, firewood gatherers and other non-vocational users. It makes light work of felling and cutting up trees, but a chainsaw deserves to be treated with respect. Carelessly used, inadequately maintained or incorrectly equipped, a chainsaw can be a lethal weapon.

The Department of Labour is concerned at the number of accidents involving chainsaws in the workplace, and has produced this guideline for anyone who is an occasional chainsaw user. It is not intended for professional forestry workers as their work is already governed by detailed safety codes.

In this guideline you will find information on chainsaw safety devices, protective clothing and equipment you should wear, and advice on safe working methods. It also gives tips on maintaining your chainsaw and other ways you can protect yourself and other people.

If you have just bought a chainsaw, you should read the manufacturer's instruction manual carefully and familiarise yourself with your chainsaw's operation. If you have not used a chainsaw before, practice the cutting techniques on a stump or log before you attempt more serious work.

You can also view our publication, A Guide to Safety in Tree Felling and Crosscutting online by visiting www.dol.govt.nz/index-publications.asp. This will tell you more about felling and cutting techniques and is also designed for non-professional chainsaw users. We suggest you keep the two booklets together with your instruction manual and refer to them from time to time to refresh your memory.

If you use your chainsaw sensibly, follow correct techniques and maintain your saw to the manufacturer's instructions, it will provide you with safe and trouble-free service.

If you're a chainsaw novice, it's an excellent idea to get training from a qualified person. This way you learn by hands-on experience and avoid developing unsafe habits right from the start. Your chainsaw dealer may be able to provide this instruction or put you in contact with a qualified instructor.

BASIC RIGHTS AND RESPONSIBILITIES UNDER THE HEALTH AND SAFETY IN EMPLOYMENT ACT 1992

WHAT ARE THE RESPONSIBILITIES FOR AN EMPLOYER?

Employers have a responsibility to make the workplace safe, and to ensure the health and safety of those working in or visiting the workplace under their control. To achieve this employers are expected to:

- Systematically identify hazards
- Systematically manage those hazards by eliminating them, isolating them or minimizing them, in that order of preference
- Provide suitable protective clothing and equipment to staff
- Provide safety information to staff
- Provide training or supervision so that work is done safely
- Monitor the environment and health of employees to ensure that their work is not having a detrimental effect on them
- Provide opportunities for employees to participate in all of the above
- Record and investigate workplace accidents
- Report serious harm accidents suffered by employees to the Department of Labour.

DO EMPLOYEES HAVE RESPONSIBILITIES?

Yes. Employees are required to take all practicable steps to ensure the safety of themselves and others in the workplace. This includes considering both the things they do and the things they omit to do (such as not using safety gear).

Employers should make clear to employees their responsibilities to use the provided safety equipment and to wear protective clothing. The expected level of an individual employee's responsibility will often be seen to increase with knowledge and seniority, but the employer's overall responsibility to ensure a safe workplace remains.

Practicable steps the employee can take also include reporting to the employer any hazards or incidents, so that the employer can investigate and put safeguards in place.

EMPLOYEES' HEALTH AND SAFETY RIGHTS

Employees are entitled to:

- Receive, for no charge, the necessary protective clothing and equipment necessary to safely do their job
- Wear their own suitable protective clothing if they wish to provide it
- Receive the results of any monitoring conducted by the employer relevant to them or their workplace
- Receive reasonable opportunities to participate in workplace health and safety.

WORK AREA SAFETY

It's important to check the work area for hazards before you start felling or cutting.

Don't do anything that will harm another person in any place where you are using your chainsaw (this includes harm to yourself).

- Check that there are no people or animals in the work area.
- Do not work in adverse weather conditions such as heavy rain, snow or high winds.
- Always ensure you have a clear work area where you have a stable footing and do not have to reach or work off balance.
- Make your way carefully on uneven or sloping ground.
- Shut the chainsaw off before carrying it. Carry it by the front handle with the bar to the rear - not on your shoulders.
- If you are felling trees:
 - Make sure other people are at least two tree lengths away;
 - Always have an escape route planned and cleared to the side and rear.
- Check for hazards in the area - such as electricity or telecommunication cables. If in doubt, seek advice from the controlling authority.
- Always check for any material such as branches or tops which may dislodge and fall into the work area as the tree falls.

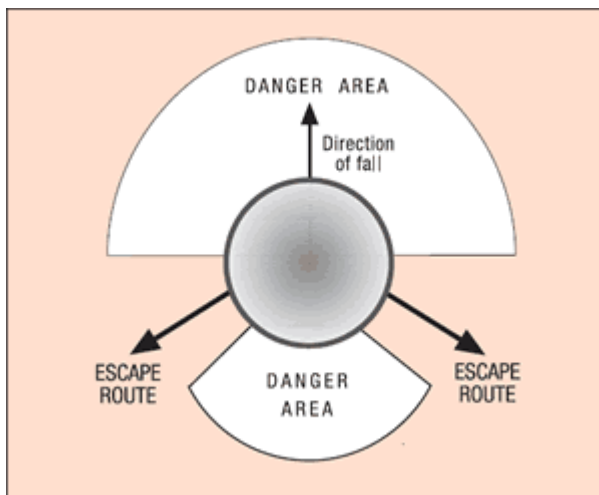

Fig 1: Have an escape route planned and cleared to the side and rear.

TRANSPORTATION

Make sure your chainsaw has a bar cover for transportation to and from the work area.

Secure all loose tools, chainsaw and fuel containers in your vehicle so that they are not damaged in transit or become missiles in the event of an accident. Don't carry equipment in the passenger compartment.

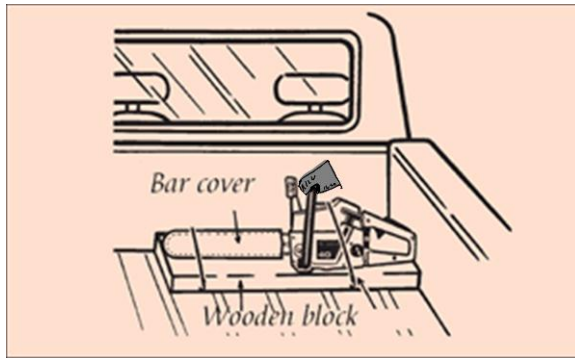

Fig 2: Secure chainsaw safely for transportation.

KNOW YOUR CAPABILITIES

Many serious accidents occur when chainsaw users tackle jobs that are beyond their capabilities.

Some felling and cutting operations are extremely dangerous and should only be undertaken by professionals or people with proper experience and training.

These include:

- Working on wind-thrown or wind-affected trees;
- Felling large shelterbelt trees;
- Felling trees with a heavy lean;
- Felling trees that have stem rot or are a species prone to splitting
- Felling trees on steep slopes or unstable ground;
- Working on or felling trees that overhang power lines, buildings or public access ways.

Always get someone who is experienced to carry out work that is beyond your capabilities.

SOME DO'S AND DON'TS

Here are some basic do's and don'ts that apply no matter how experienced you are:

- Do not operate a chainsaw above shoulder height or above ground level, such as in a tree or off a ladder, unless qualified and experienced to do so.
- Always have someone within calling distance - never work alone while using a chainsaw.
- Never operate your chainsaw under the influence of alcohol or drugs.
- Never operate your chainsaw when you are fatigued. If you get tired when using your chainsaw, have a rest - you need to stay alert and be in control.
- Your chainsaw is designed to cut wood - never cut any other material or use your chainsaw guide bar for levering or digging.
- Always match the size of your chainsaw and bar with the material being cut. Don't try to use a small chainsaw and bar to fell a large tree.



Fig.3: Felling trees with a heavy lean or under tension is a job best left to the experts.

TYPES OF CUTS

Different types of cuts include:

- **Felling cut** - Cuts placed into the stem of tree or branch to sever it and fall in the desired direction
- **Horizontal bore cut** - With the chainsaw placed on its side and using the tip of a chainsaw to cut into a tree or log.
- **Trimming** – the cutting/removal of branches from the stem of a tree

CHAINSAW SELECTION

ELECTRIC OR PETROL

Electric chainsaws are generally less expensive, but less powerful. With an electric chainsaw, you have no engine to feed and maintain, but you do have an extension cord to manage. Electric chainsaws are quieter and cleaner, and have less vibration.

Petrol powered chainsaws can be used anywhere without worrying about a power supply, but are noisy and smoky. Petrol chainsaws can be hard to start if not properly maintained, especially since they may not be used for months at a time. Petrol chainsaws are available in a wide range of engine and bar sizes.

TOP HANDLE CHAINSAWS

These chainsaws have the rear handle positioned over the top of the engine. They are intended only for use by trained Arborists working up in trees. Only use top-handled chainsaws if you have received instruction in their safe use and always use them two-handed.

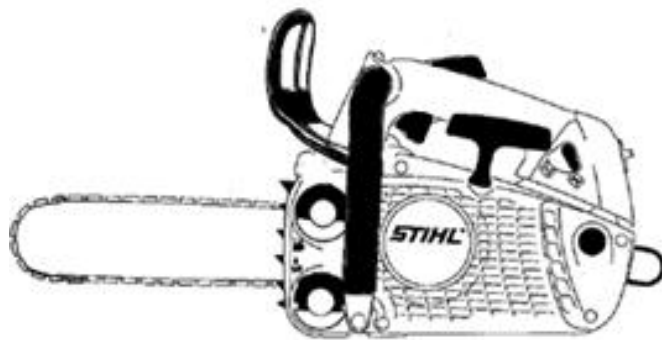

Fig4:Top-handled chainsaw

KNOW YOUR CHAINSAW

All modern chainsaws have safety devices designed to help you keep control of it and so reduce the severity of accidents. You need to understand how they work. But remember - these devices are no substitute for training and experience.

SAFETY MITT, HAND GUARD OR CHAINBRAKE

SAFETY MITT

A leather safety mitt securely attached to the front handle but free to rotate on it helps to keep your left hand on the handle in case of kickback. It also provides protection for your hand.

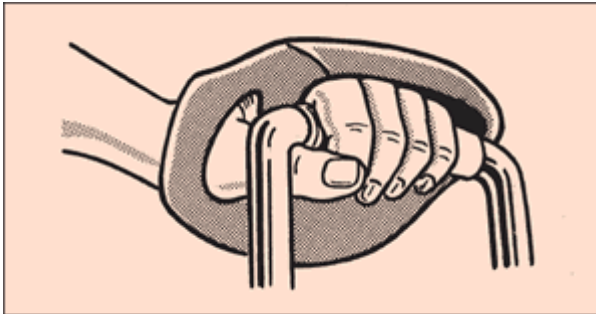

Fig 5: Chainsaw mitt helps keep your hand on the handle.

While you are handling your chainsaw, ensure that your thumb remains firmly wrapped around the front handle at all times. This will ensure that in the event of a kickback your hand will not slip off the front handle.

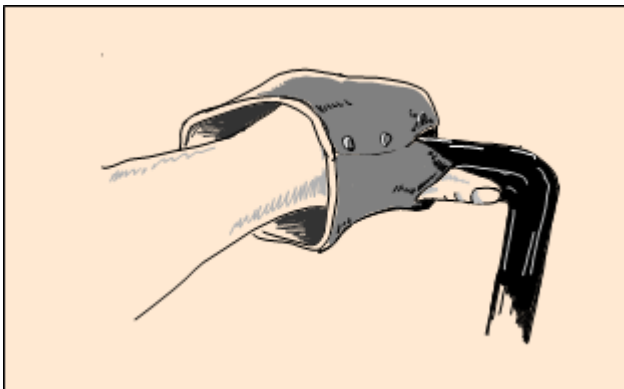

Fig 6: Thumb in an extended and potentially unsafe position

RIGID FRONT HANDLE GUARD

This helps to prevent your left hand from touching the chain if it slips off the front handle.

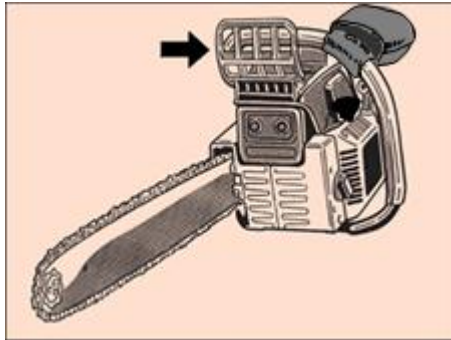

Fig 7: Rigid front handle guard helps to protect your hand from the chain.

CHAINBRAKE

The chainbrake is designed to stop the moving chain if the front guard is moved forward. It can be activated if the chainsaw rotates about its axis in a kickback situation and your left hand swivels on the front handle and contacts the front guard. You can also activate the chainbrake manually.

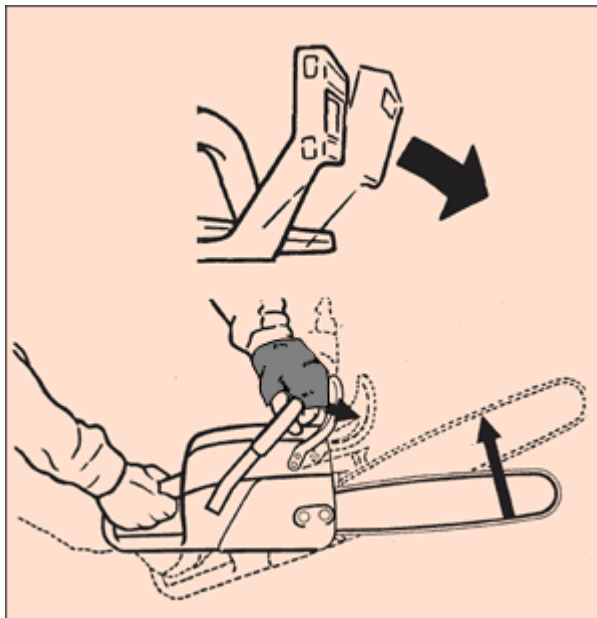

Fig 8: Chainbrake stops chain when guard is moved forward.

INERTIA CHAINBRAKE

A recent development in chainsaw technology, this braking system has the advantage that it will automatically trigger the brake in any position as soon as a kickback starts. This is especially important when you are using the chainsaw with the guide bar in the horizontal position while making a felling cut, a horizontal bore cut or when trimming. In these situations a manual chainbrake would not be activated if a kickback occurs. All chainsaws sold in New Zealand must have a compliant chain brake.



Fig 9: Inertia chainbrake triggers brake in any position when kickback occurs.

STOP SWITCH

This is located so that it can be operated with your right hand remaining on the rear handle.

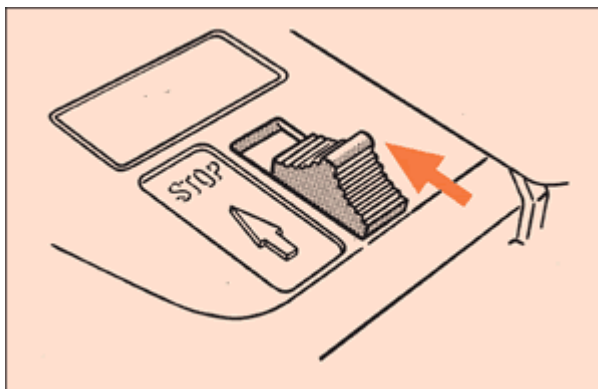

Fig 10: Stop switch can be operated while your hand is on rear handle.

THROTTLE CONTROL LOCKOUT

This prevents the accidental opening of the throttle. The throttle control is locked in the idle position when the lockout is not pushed in by your right hand gripping the rear handle.

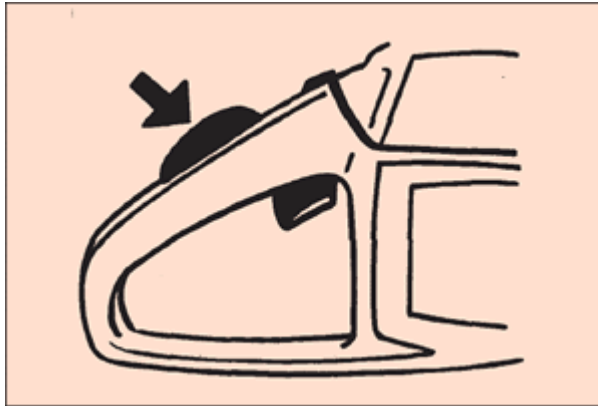

Fig 11: Throttle control lockout prevents accidental opening of throttle.

REAR HAND GUARD

The lower part of the rear handle is widened to protect your hand in case of a chain breakage or slippage.

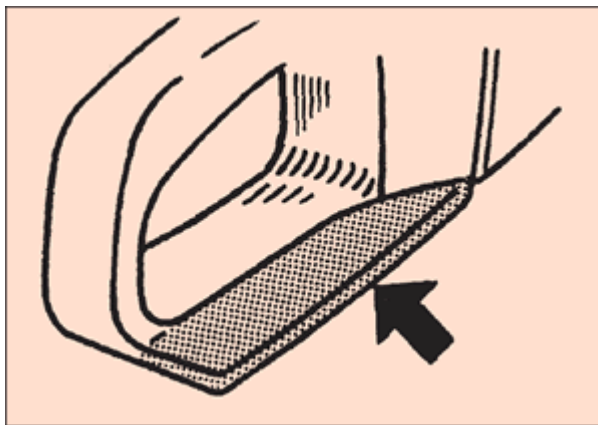

Fig 12: Rear hand guard is designed to protect your hand if chain breaks.

CHAIN CATCHER

This is designed to catch a broken, slipping, or jumping chain.

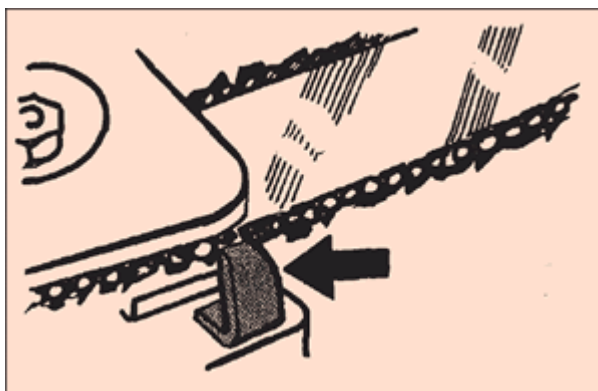

Fig 13: Chain catcher is designed to catch broken or jumping chain.

VIBRATION DAMPING SYSTEM

This system isolates the motor and handles to reduce vibration.

BAR AND CHAIN COMBINATION

Using the correct combination of guide bar and chain reduces the possibility of kickback. The bar length should be matched with the power of the motor unit and the material being cut.

Correct chain sharpening, depth gauge settings and tensioning are essential for good performance and improved safety.

Check the guidelines outlined on pages 28-36 of this booklet.

MUFFLER

Noise levels from two-stroke engines are high. The muffler is designed to decrease noise levels, direct gases away from you and act as a spark arrestor. Don't use a chainsaw with a missing or damaged muffler.

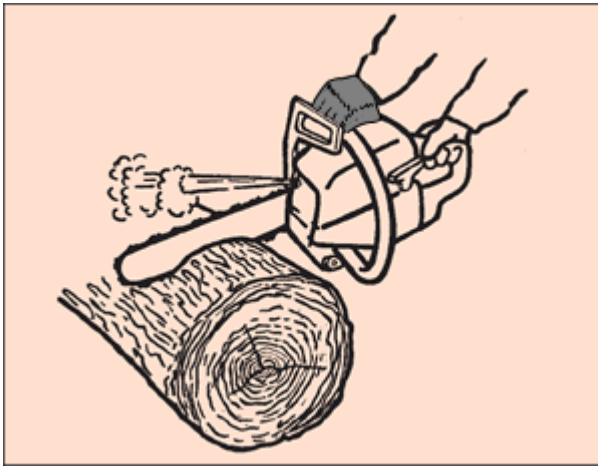

Fig 14: Among other things, muffler reduces noise levels.

PERSONAL SAFETY EQUIPMENT

As well as using appropriate safety equipment, chainsaw users should wear protective clothing which complies with New Zealand Standards or their overseas equivalents.

Invest in the same equipment the professionals use. When you buy your safety equipment, make sure that it bears a NZ Standards number or "S" mark. This is a guarantee that it has been manufactured to stringent standards to offer maximum protection.



Fig 15: NZ Standards mark of compliance

WHAT YOU NEED

FOOTWEAR. Boots should have steel toe caps and give firm ankle support. Lace-up types must be securely fastened so that you don't trip on the laces.

LEG PROTECTION. Wear good-quality chainsaw operators' safety trousers or chaps. These should be to AS/NZs 443.3:1997.

SAFETY HELMET. Wear a helmet to protect your head from falling objects and to minimise the risk of injury to the face in the event of a kickback

EARMUFFS. Wear earmuffs rated Class 5.

EYE PROTECTION. If you are working in very dusty conditions, wear goggles. If there's a danger of flying debris, use a helmet visor.

GENERAL CLOTHING. This should fit fairly closely but be comfortable and allow free movement.

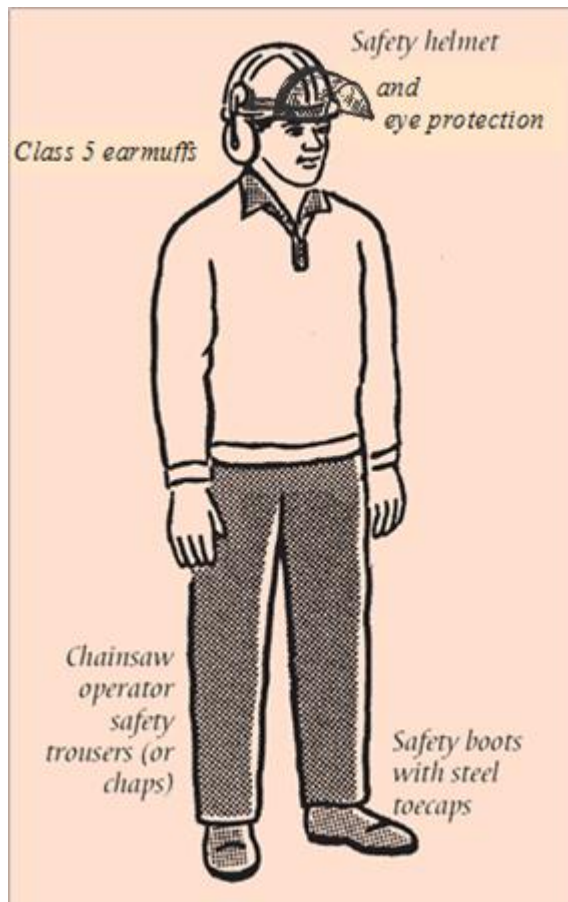

Fig 16: This is the safety equipment the Department of Labour recommends. For professional chainsaw users, all this equipment is compulsory.

FIRST AID KIT. Have a small kit with at least two large sterile wound dressings and keep it in good condition. Clean it, keep it dry and replace any broken or damaged components.

WEDGES

Wedges are an indispensable aid for directional tree felling or to hold open cuts that may bind or pinch. The best choice is a high-density plastic wedge as used by many professional fellers. These are light-weight and inexpensive.

You'll need a mallet or suitable tool to drive in the wedges.

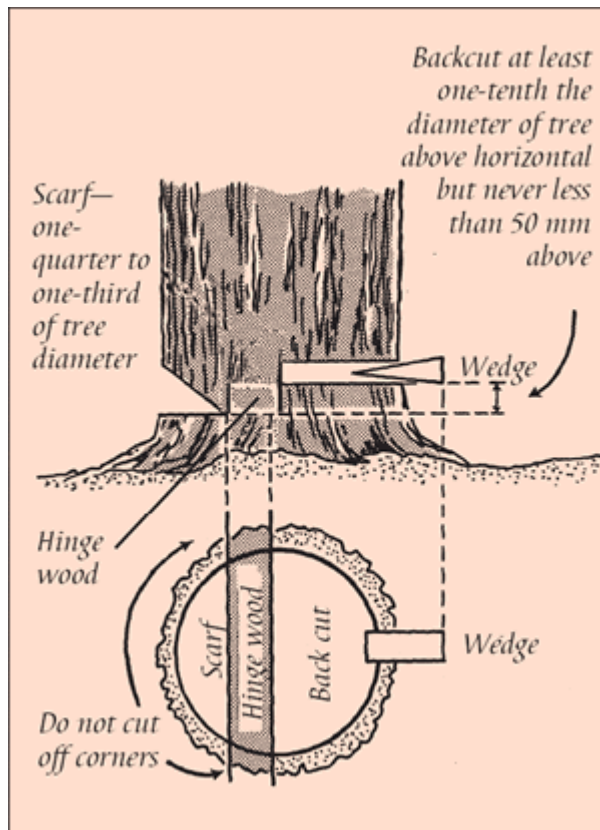

Fig 17: Wedges are useful for directional tree felling or to hold open a cut that may bind or pinch.

CHECKING YOUR CHAINSAW

Make these checks - which only take a minute or two - part of your routine whenever you get your chainsaw out.

- Check that your chainbrake is in working order or you have a rigid-type hand guard fitted or a mitt securely laced to the front handle.
- Check that the lubrication system is working - rev the engine and operate for a few seconds before switching off. Check the chain to ensure it is properly lubricated.
- Alternatively, activate the oiler while pointing the bar towards an object such as a stump and wait for the oil to show up. Remember that kickback can occur if you get too close to the object.
- Check that the throttle control lockout, throttle control trigger and the on/off switch are operating correctly.
- Check that the chain is sharpened and tensioned to the manufacturer's instructions. When the cutters are sharp, with correct angle and depth gauge settings, the chain will do the work. When the chain is incorrectly sharpened and maintained, you work harder by having to force the chainsaw into the cut.
- Check that the chain stops moving when the throttle control trigger is released. The chain should not rotate while the saw is idling.
- Check that all external fittings are secure - check nuts, bolts, etc.
- Check that the high-tension lead does not show signs of wear, especially where it passes through the body of the chainsaw.

Pay particular attention to these checks if you've lent your chainsaw to anyone - they may not have taken the same care that you do!

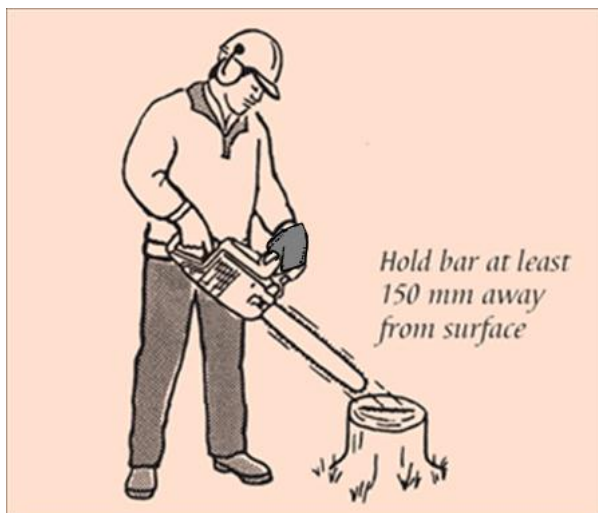

Fig 18: Check that chain is properly lubricated.

SOME DO'S AND DON'TS

- Never operate a chainsaw that is damaged, not properly adjusted to the manufacturer's recommendations, incorrectly assembled or with parts missing, especially safety devices.
- Except for fine-tuning the carburettor, never adjust chainsaw parts while the motor is running.
- Always turn your chainsaw off when handling the chain, guide bar or sprocket.

STARTING THE CHAINSAW

There are two recommended methods of starting. These are known as cold starting and warm starting.

COLD STARTING

See the owner's manual for setting the choke and throttle control lockout.

- Place the chainsaw firmly on the ground. If a chainbrake is fitted, put the brake on.
- Hold your left arm straight, with the front handlebar firmly cradled between the thumb and fingers. If a mitt is fitted, your hand must be in the mitt.
- Place the front of your right foot in the rear handle, or place a knee on the chainsaw body.
- Position your other leg to provide stability.
- Pull the starter cord with your right hand, using short sharp pulls to start the motor.
- When started, close the choke and release the throttle control latch by squeezing the throttle control trigger.



Fig 19: Cold starting method.

WARM STARTING

- Place your left hand in the safety mitt if fitted. Keep left arm straight.
- Position chainsaw on left thigh pointing left.
- Step over rear handle and secure chainsaw behind bent right knee.
- Start with short sharp pulls on the starter cord.
- If the chainsaw does not start, revert to the cold start method.

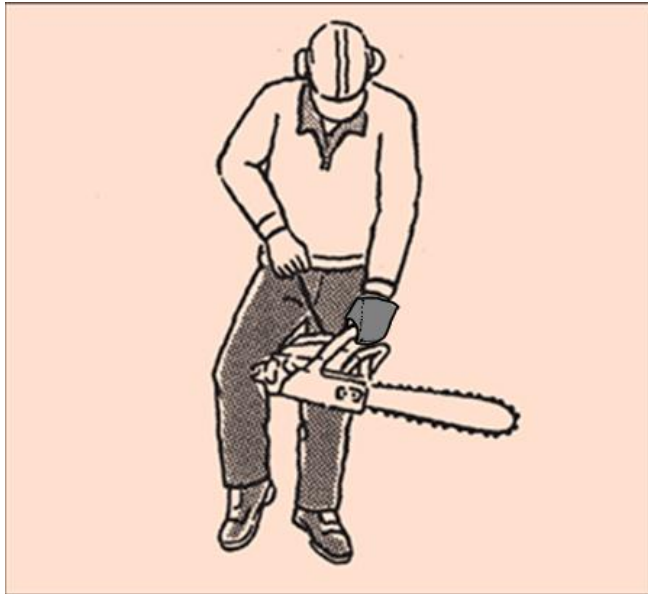

Fig 20: Warm starting method.

WARNING ON DROP-STARTING

NEVER DROP-START A CHAINSAW. The danger is that it will swing in an arc at the end of the starting cord and cause serious injury, especially to the body or face.

CUTTING WITH THE CHAINSAW

It's important that you hold the chainsaw correctly and adopt the proper stance. It's also necessary to know the different types of cutting actions.

HOLDING THE CHAINSAW

Place your left hand on the front handle and ensure the handle is gripped between thumb and finger, with your thumb under the handle. Use the mitt if fitted. Your right hand should grip the rear handle, with your index finger on the throttle trigger.

Maintain control of the chainsaw while the motor is running by keeping a firm grip with both hands.

- Keep your feet firmly planted slightly apart in a balanced position. Do not over-reach. Move feet closer to the cutting position.
- Hold the chainsaw close to your body with the chainsaw body close to the cut for better control. Slightly bent arms will improve your control over the chainsaw.
- Position yourself to the side of the intended cut to lessen the chance of injury from kickback.
- Never use the chainsaw with one hand as you can easily lose control over it.
- Start the cut at high speed and maintain engine speed as you cut.
- When the cut is almost finished, reduce speed to avoid a sudden finish with loss of balance, or the guide bar and chain hitting the ground or other objects.
- Regularly check chain tension and ensure that chain is correctly sharpened.

TYPES OF CUTTING ACTION

There are three main types of cutting action. You need to understand the differences in order to avoid accidents or dangerous situations.

THE DOWN CUT

This cut uses the bottom of the bar. It is the safest and easiest cut as the chain action draws the chainsaw towards the cut and away from the operator. This is called traction.

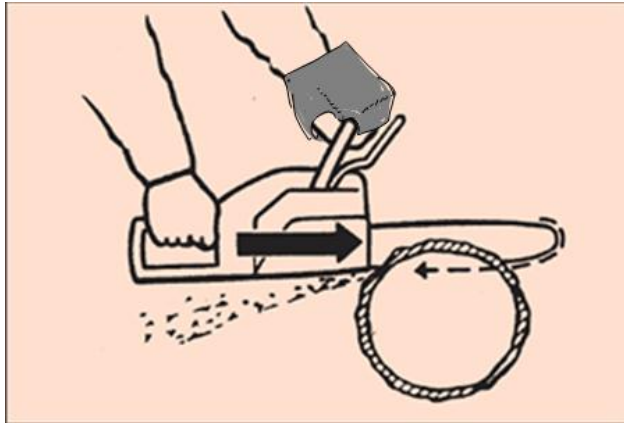

Fig 21: The down cut draws chainsaw towards the cut.

THE UP CUT

This uses the upper part of the bar. The chain's reactive force will push the chainsaw away from the cut and towards you. There is a risk of kickback if the chainsaw is pushed far enough away from the cut for the nose of the bar to ride out of the cut.

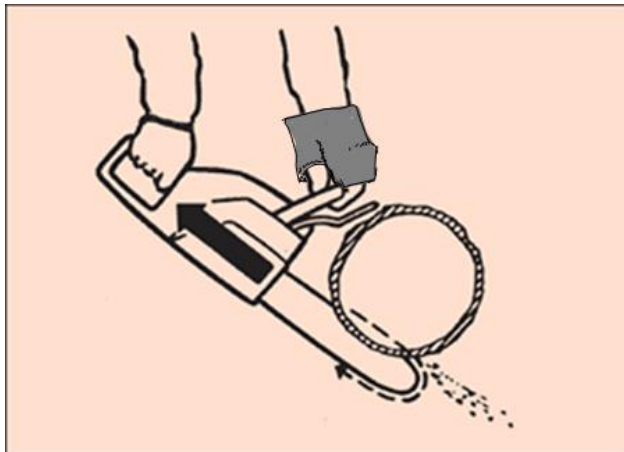

Fig 22: The upcut pushes chainsaw away from the cut.

THE BORING CUT

This cut starts by using the bottom portion of the nose of the bar and then the upper portion as the cut proceeds. Because of the likelihood of kickback, this cut should be used only by trained or experienced operators.

Proceed as follows:

- Using the lower tip of the guide, bar cut until the depth is about bar width.
- Align the chainsaw towards the horizontal with the chainsaw at full throttle.
- Still at full throttle, press the guide bar straight into the log.

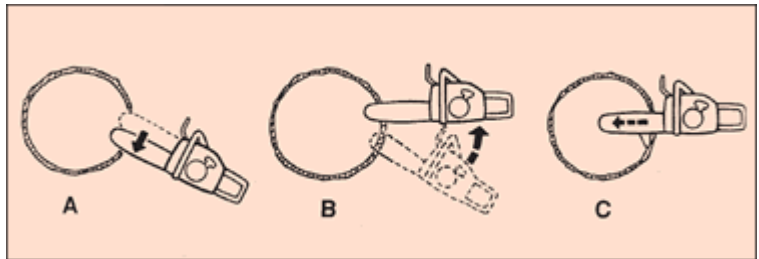

Fig 23: The boring cut - for experienced operators only.

AVOIDING KICKBACK

Kickback is a potential danger when-ever you use your chainsaw. You need to know why it occurs and how to reduce it.

WHAT IS KICKBACK?

Kickback occurs when the upper part of the bar nose contacts a solid object or is pinched. This causes a reactive force that may throw the guide bar in an uncontrolled arc towards you and can result in serious injury.

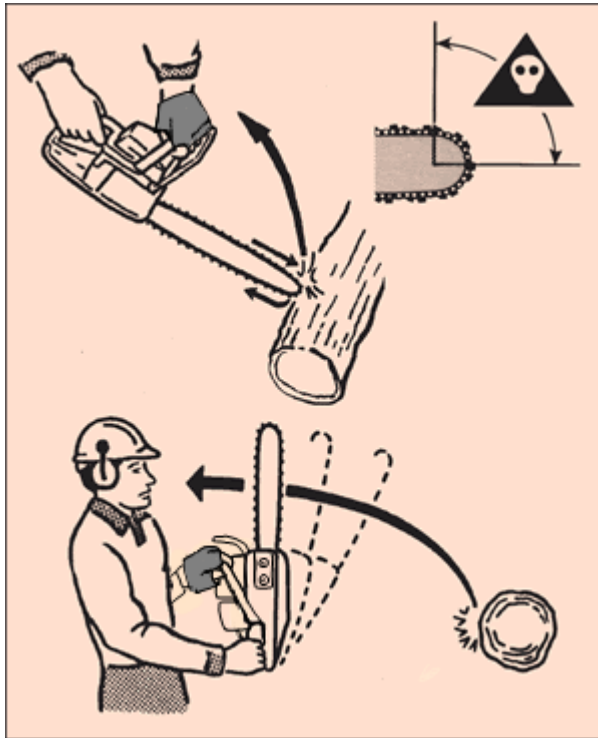

Fig 24: Chainsaw kicks back when critical area of bar nose contacts wood or is pinched.

Kickback can occur when:

- The bar nose hits hidden limbs or light material.
- The chainsaw is boring into a log (as explained on page 23).
- The bar nose is pinched while cutting.
- The bar nose contacts ends of logs or obscured material.
- The chain is loose.
- The depth gauge setting is too low.

Remember that kickback can occur in any plane. It may occur when using the chainsaw with the guide bar horizontal when making a felling cut, while making a bore cut or while trimming.

HOW TO REDUCE KICKBACK

Using proper operating techniques will reduce the likelihood of kickback.

- Hold the chainsaw firmly with both hands.

- Make sure your left thumb is wrapped firmly under the front handle and in the mitt if fitted.
- Be aware of the location of the guide bar nose at all times.
- Do not let the guide bar nose come in contact with any object.

Other points to watch are:

- Be especially careful when cutting small limbs or light material that may catch in the chain.
- Do not over-reach or cut above shoulder height.
- Use extreme caution when re-entering a cut.
- Cut only one log at a time.
- Correctly maintain your chainsaw.
- Make sure there are no loose-fitting nuts, bolts or screws.
- Ensure that safety devices are working.
- Make sure the chain is tensioned, sharpened and depth gauges set to the manufacturer's specification.
- Use a safety chain (anti-kickback chain) and the correct bar and chain combination.

REFUELLING THE CHAINSAW

Petrol - especially petrol vapour - can easily be ignited by a spark or even a hot surface while refuelling the chainsaw. If you're careless, there's a risk of being badly burnt.

Follow the safe procedures:

- Stop the motor.
- Place the chainsaw on clear ground.
- Fill the oil tank first to allow the chainsaw to cool down.
- Take care not to spill fuel on hot motor components.
- Wipe any spilt fuel from the chainsaw.
- Move at least three metres away from the fuelling point before restarting.
- Do not smoke while refuelling your chainsaw.
- Do not use glass containers for fuel or oil. Use a properly constructed metal or approved container that does not leak. Note: Consult your owner's manual for correct fuel/oil mixtures as serious damage can be caused by incorrect mixes.

CARE OF YOUR CHAIN

In many ways the chain is the most important part of your chainsaw. It is the part that needs the most attention but fortunately maintenance is not too difficult for the average user.

DANGEROUS CHAIN CONDITIONS

Any of the following conditions can increase a chain's potential kickback energy or increase the hazards to the operator:

- Incorrect sharpening angles of the chain.
- Excessive or incorrect depth of gauge settings.
- Loose chain tension.
- A dull chain.
- Any alteration to kickback-reducing features.

FOUR RULES FOR CHAINS

There are four basic rules to ensure that your chainsaw chain performs safely and well.

Keep the chain:

- Well oiled;
- Correctly tensioned;
- Sharp, with correct cutter angles; and
- The depth gauge height to the 'cutter' is correct.

OILING

A constant supply of oil to your chainsaw's guide bar, chain and sprocket is essential to prevent excessive friction wear and damage.

Regularly check that the chain oiling system is working.

Always use chain lubricating oil or oil recommended by the manufacturer. Never use waste or used oils - these contain impurities that can damage the chain, and the oil mists thrown off the chain can cause health problems.

TENSIONING

Loose chains can affect the depth gauge effectiveness and result in greater kickback potential and increased guide bar and sprocket wear. It may also cause the chain to jump off the guide bar.

The chain should be tensioned so that it is touching the whole way around the guide bar. The chain should fit snugly but still be easily pulled forwards from the chainsaw body towards the guide bar tip.

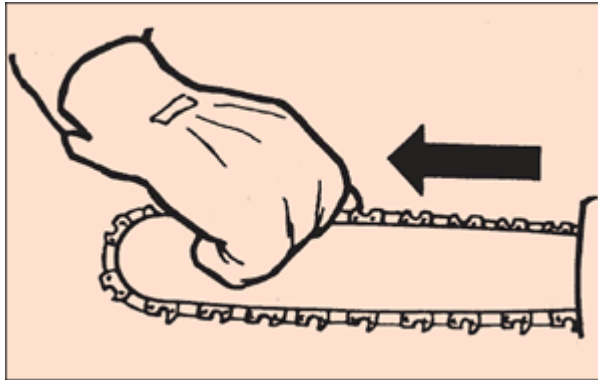

Fig 25: Regularly check chain tension and correct as necessary.

Tension the chain before each use. Tension the chain often, or at each refuelling.

Never tension your chain right after cutting.

A chain tensioned while hot can cool and shrink, causing tension to be too tight. Let the chain cool first.

Always wear protective gloves.

Follow these steps:

- Turn the engine off.
- Loosen bar-mounting nuts on the side of your chainsaw.

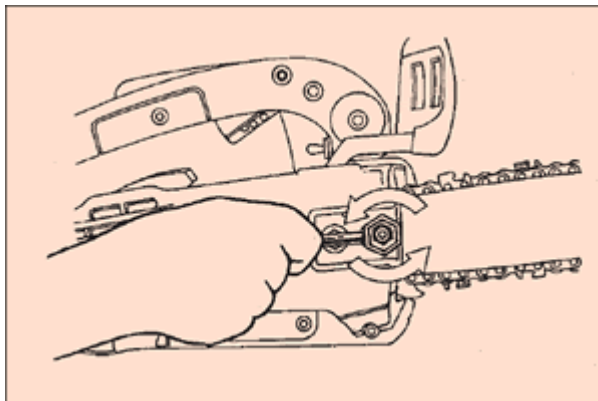

Fig 26: Loosening the bar-mounting nuts

- Adjust tension as follows:
 - (a) If you have a solid-nose bar

Pull the bar nose up and keep it up as you adjust tension.

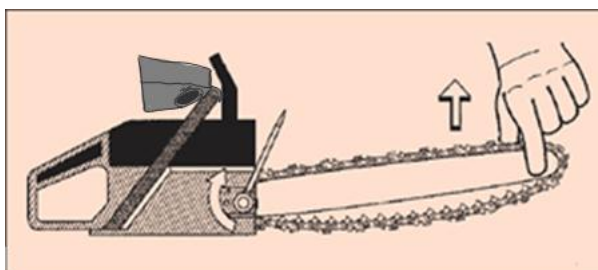

Fig 27: Pulling the bar nose up

Turn your chainsaw's tension adjustment screw until the bottoms of the lowest tie straps and cutters come up and just touch the bottom of the bar rail.

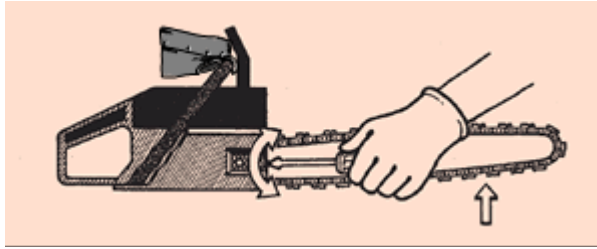

Fig 28: Adjusting the tension so the straps and cutters just touch the bar rail

While still holding the nose up, tighten your chainsaw's rear bar-mounting nut first, then tighten the front mounting nut.

(b) If you have a standard sprocket-nose bar

Pull the bar nose up, and keep it up as you adjust tension.

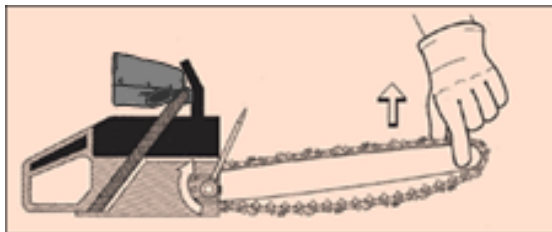

Fig 29: Pulling the bar nose up

Tension must be tighter on a sprocket-nose bar than on a solid-nose bar. Turn your chainsaw's tension-adjustment screw until the bottoms of the lowest tie straps and cutters come up and solidly contact the bottom of the bar rail. Then add an additional quarter-turn of the adjustment screw.

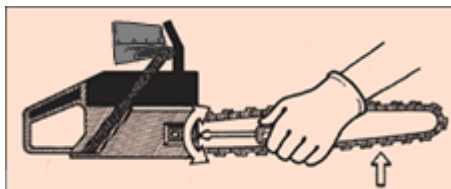

Fig 30: Adjusting the tension so the straps and cutters solidly contact the bar rail

While still holding the nose up, tighten your chainsaw's rear bar-mounting nut first, then tighten the front mounting nut.

(c) If you have an Intenz™ sprocket-nose bar

Turn the tension-adjust slot until the bottoms of the lowest cutters and tie straps come up and solidly contact the bottom of the bar rail.



Fig 31: Adjusting the tension so the straps and cutters solidly contact the bar rail

Tighten your chainsaw's rear bar-mounting nut first, then tighten the front mounting nut. It is not necessary to hold the nose up when adjusting tension on Intenz™ bars.

NOTE: When replacing a standard bar with an Intenz™ bar, the chainsaw's adjustment pin must be removed. Contact your dealer if you need help.

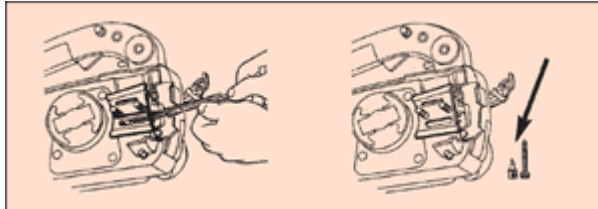

Fig 32: Remove the adjustment pin

Pull the chain by hand along the top of the bar several times, from the engine to the bar's tip. The chain should feel snug but still pull freely.

If you have a sprocket-nose bar, you should now perform the snap test. Grasp the chain along the bottom of the bar, pull down, and let go. Chain should snap back to its original position, solidly contacting the bottom of the bar.

Check tension often during operation, especially during the first half hour. If the chain loosens: stop, let the chain cool, and readjust tension.

SHARPENING

When it is sharp, with correct cutter angles maintained, your chain does the work.

If not, you do the work, safe working conditions are reduced and excessive chain wear can result.

Let's look at the parts of a cutter.

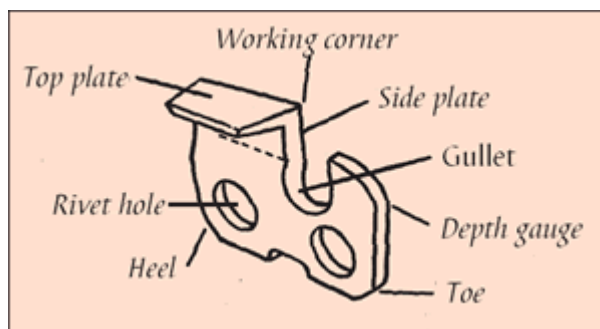

Fig 33: The parts of a cutter.

There is a range of angles for cutters, which are illustrated below.

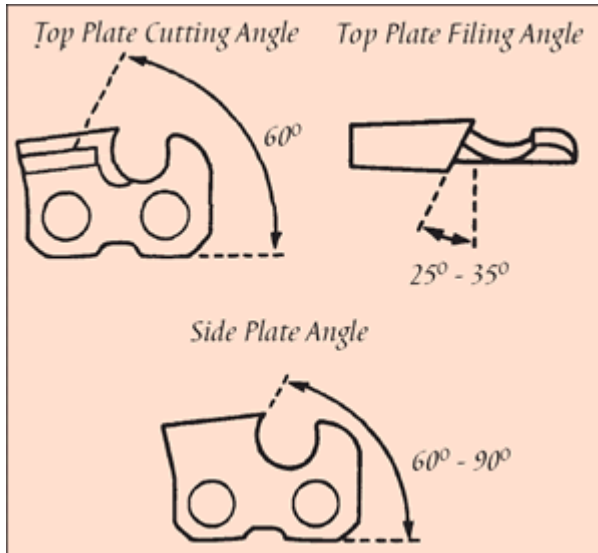

Fig 34: There is a range of angles for cutters.

You should sharpen your chain to the manufacturer's recommendations for your particular chain. The basic tools you need are a round file with handle and a file guide, which you can buy from your chainsaw dealer.

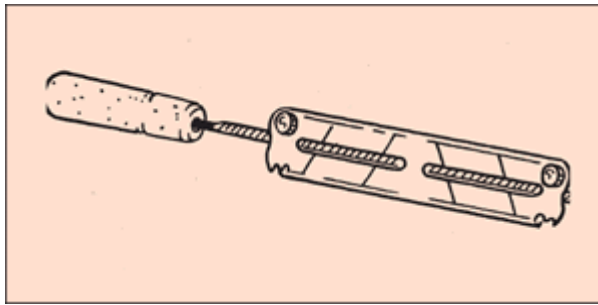

Fig 35: Basic tools are a round file and a file guide.

All cutters should be kept to an equal length and shape for the life of the chain. Use the correct file guide to ensure the file is held at the proper depth and angle. Do not use a file without a handle.

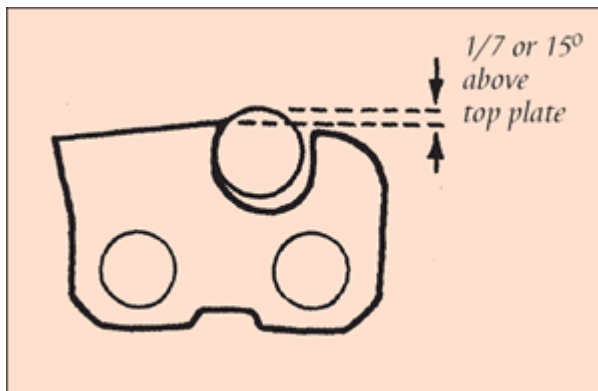

Fig 36: Use the correct file guide to ensure the file is held at the proper depth and angle.

File from the inside out with smooth strokes of the file, using the file guide to maintain the correct angle.

Sharpen cutters on one side of the chain first and repeat for the other side. If cutters are damaged, repair by filing them back to correct shape or replace if necessary. File replaced cutters back to the same length as the rest.

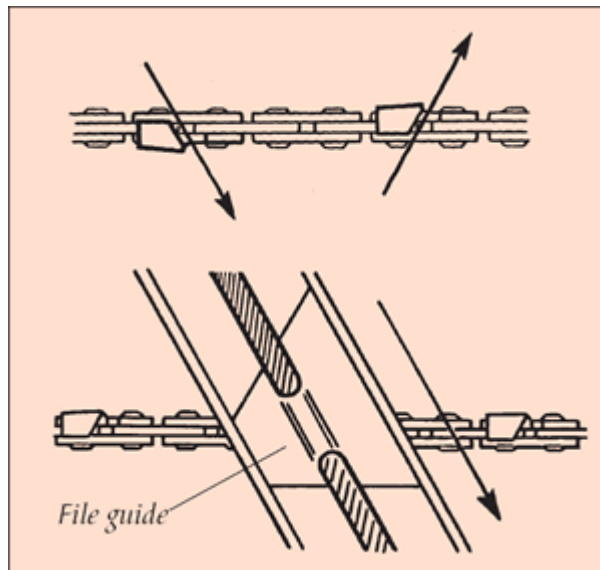

Fig 37: Use the file guide to maintain correct angle.

DEPTH GAUGE SETTING

The depth gauge controls the thickness of the chip the cutter will remove. Their proper maintenance is essential for good performance and safety.

Basic tools are a flat file and the correct depth gauge tool as recommended by the manufacturer.

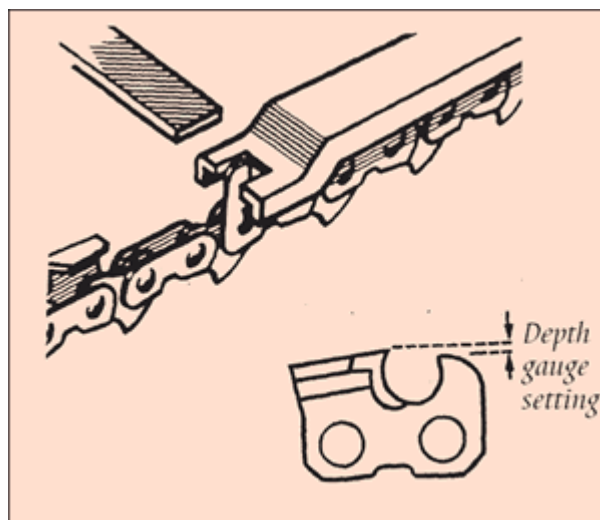

Fig 38: Use a flat file and correct depth gauge tool.

Place the depth gauge tool in position and file from the inside of the cutter outwards.

After lowering depth gauges, file off the leading edge and maintain the original shape of the depth gauge.

Check depth gauges after 4-5 sharpenings.

Note: When you have to replace the chain on your chainsaw, replace the sprocket as well.

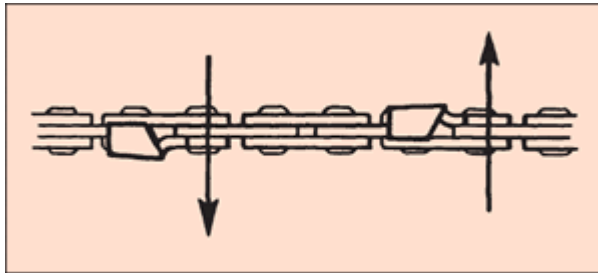

Fig 39: File from the inside of the cutter outwards.

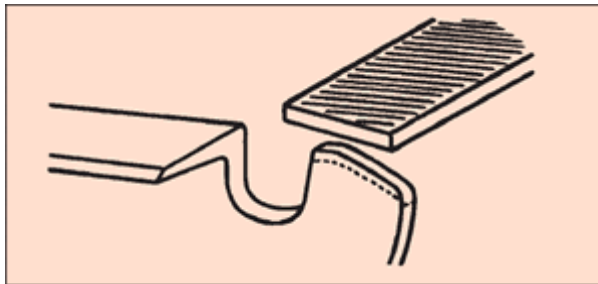

Fig 40: Maintain original shape of the depth gauge.

AVOIDING HEALTH PROBLEMS

There are a few health hazards associated with chainsaw use that you should be aware of.

EXHAUST FUMES

Exhaust fumes contain carbon monoxide, which can make you feel drowsy and cause you to lose concentration, increasing the risk of an accident. Ensure that you use chainsaws in well ventilated areas only.

HEARING LOSS

The noise generated by a petrol-driven chainsaw can start to damage your hearing after just a few minutes' use. The longer the exposure, the greater the likelihood you will suffer permanent noise induced hearing loss.

To protect your hearing, make sure you wear Class 5 earmuffs, as worn by industry professionals.

VIBRATION DISEASE

This results in "white finger", which is caused by a reduced flow of blood to the finger extremities. Excessive vibration can increase the likelihood of vibration disease.

Make sure your chainsaw is properly tuned, regularly check the fastness of the anti-vibration mounts and chainsaw parts, and keep the chain depth gauge settings and chain sharpening to the manufacturer's instructions.

GENERAL CHAINSAW MAINTENANCE

Finally, keep your chainsaw clean and well maintained. Not only will it be safer to use, but it will also prolong the chainsaw's life.

Regularly:

- Clean your chainsaw, particularly the air filter cooling inlets, sprocket cover and chain brake mechanism.
- Clean the guide bar groove and oil holes.
- Check the guide bar for straightness, burring and wear of the rails.
- Turn the guide bar regularly to ensure even wear.
- Check the sprocket and chain for wear.
- Check the chain for cracked rivets or side links.
- Check all nuts, bolts and screws for correct tension.
- Ensure that all components are in place.



⇒ More information

www.dol.govt.nz

0800 20 90 20

Information, examples and answers to your questions about the topics covered here can be found on our website www.dol.govt.nz or by calling us free on 0800 20 90 20.

